

**WIRING DIAGRAM**

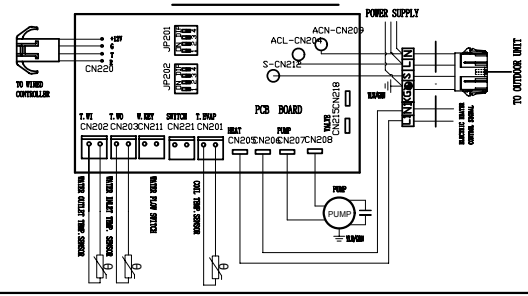

Total system graph

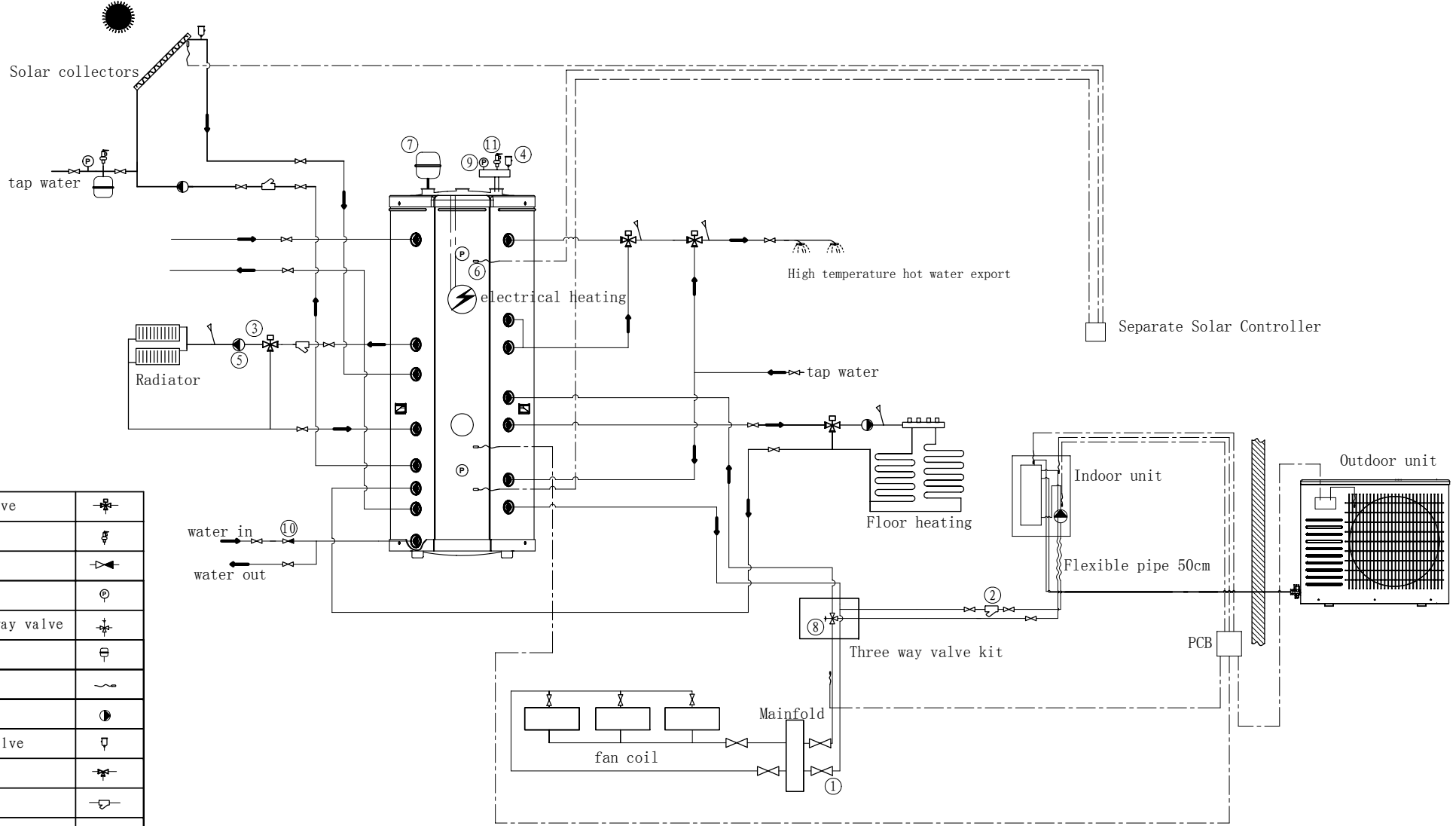

12	water mixing valve	
11	safety valve	
10	non-return valve	
9	pressure gage	
8	electric the 3-way valve	
7	expansion tank	
6	sensor	
5	water pump	
4	automatic air valve	
3	shunt valve	
2	filter ball	
1	shutoff valve	
No	Name	legend

WIRING DIAGRAM

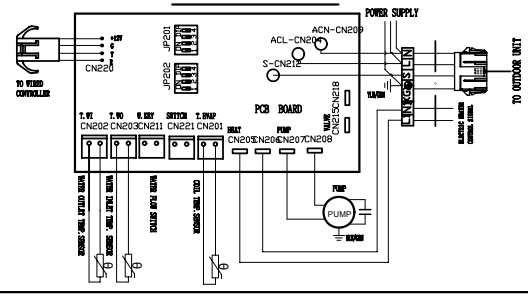

1、AIR WATER + MULTIFUNCTIONAL TANK.

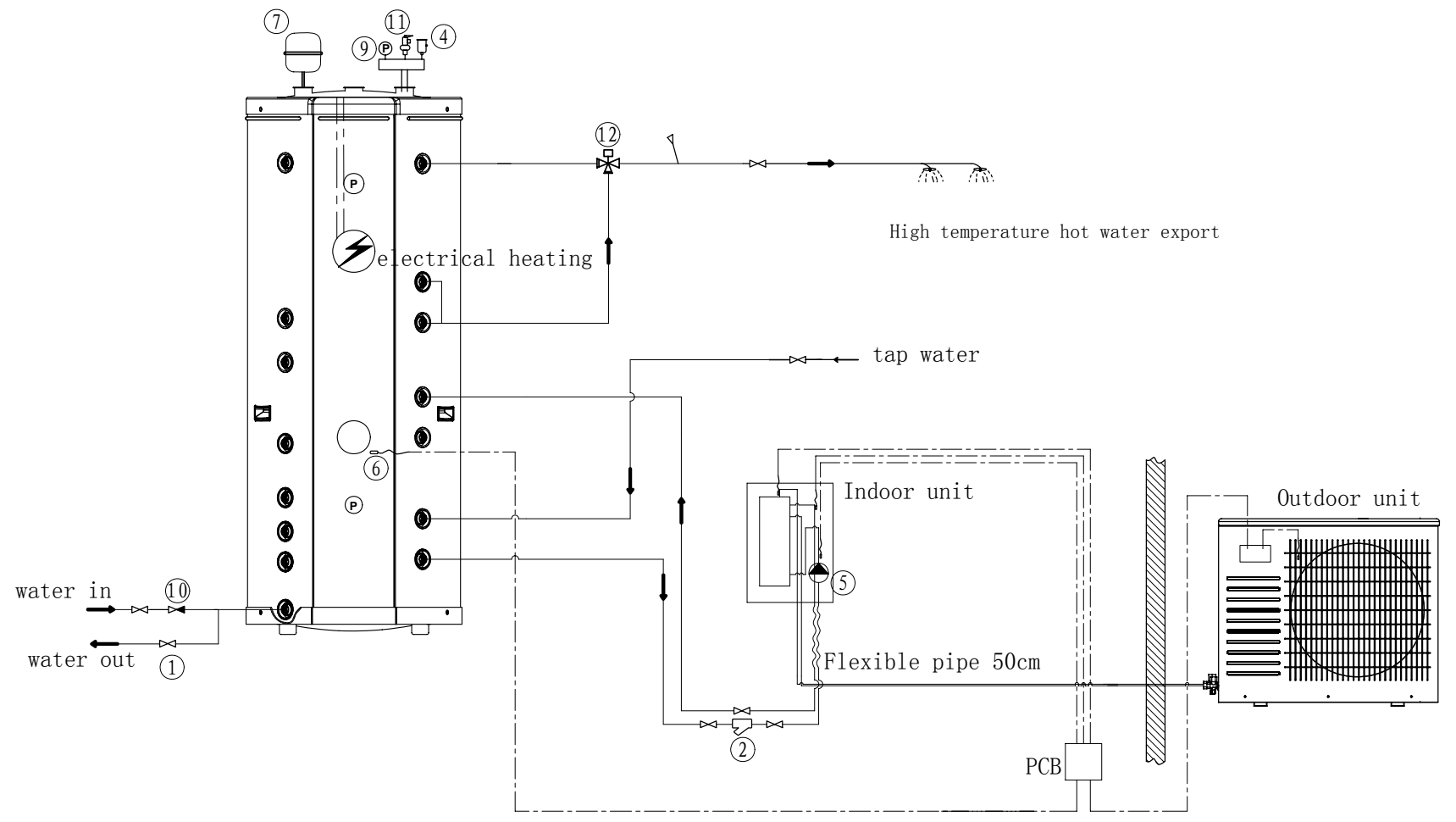

12	water mixing valve	
11	safety valve	
10	non-return valve	
9	pressure gage	
8	electric the 3-way valve	
7	expansion tank	
6	sensor	
5	water pump	
4	automatic air valve	
3	shunt valve	
2	filter ball	
1	shutoff valve	
No	Name	legend

**WIRING DIAGRAM**

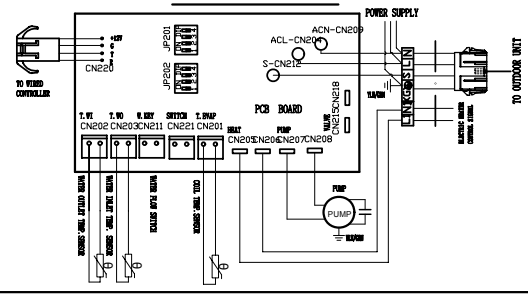

2、AIR WATER + MULTIFUNCTIONAL TANK  
+ SOLAR COLLECTORS.

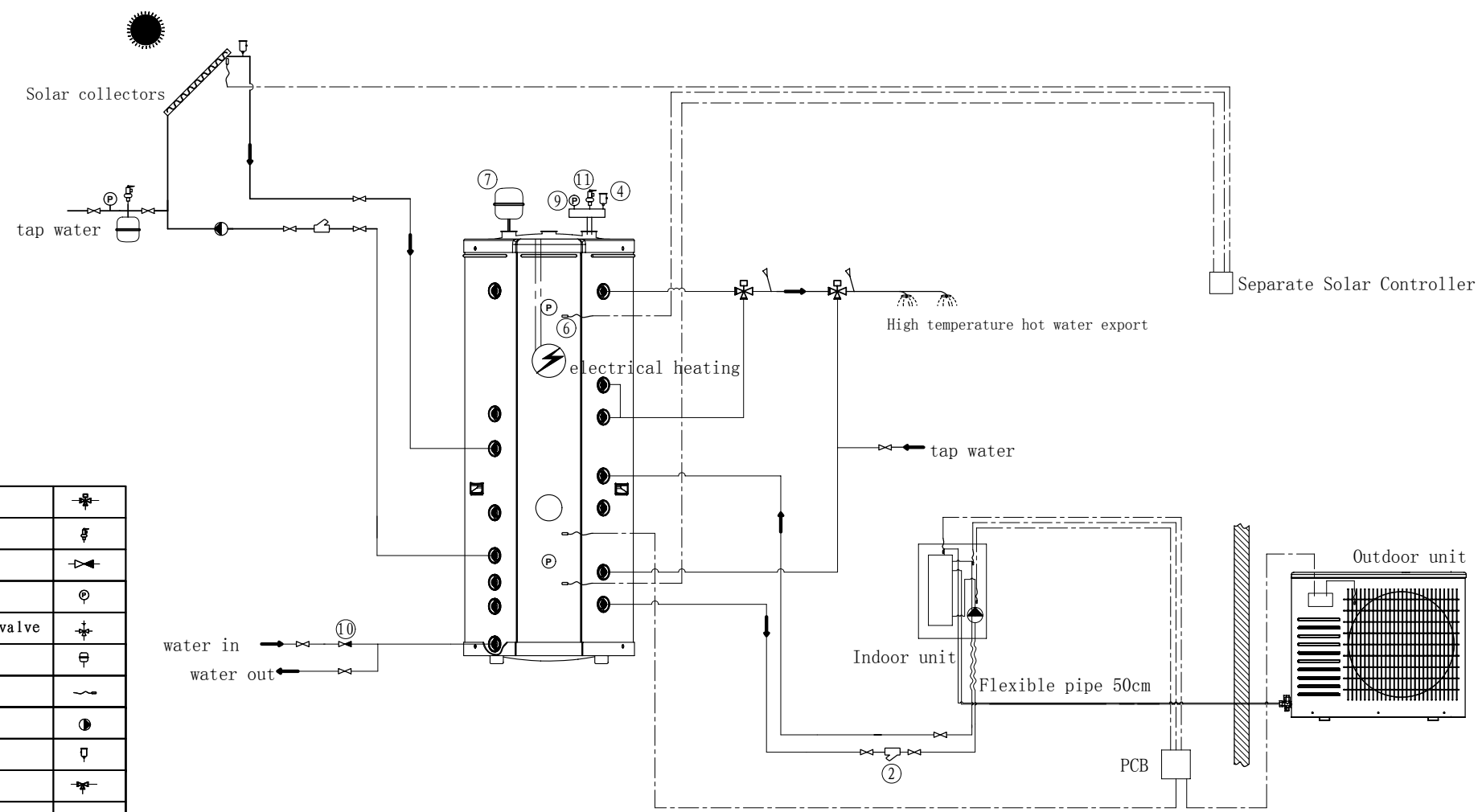

12	water mixing valve	
11	safety valve	
10	non-return valve	
9	pressure gage	
8	electric the 3-way valve	
7	expansion tank	
6	sensor	
5	water pump	
4	automatic air valve	
3	shunt valve	
2	filter ball	
1	shutoff valve	
No	Name	legend

WIRING DIAGRAM

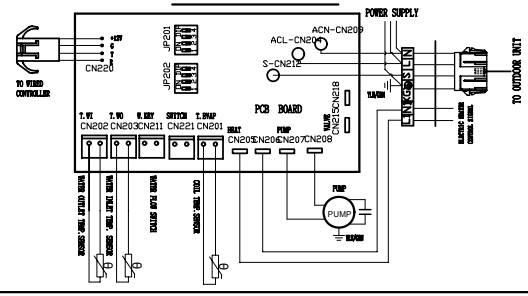

3、AIR WATER + BOILER.

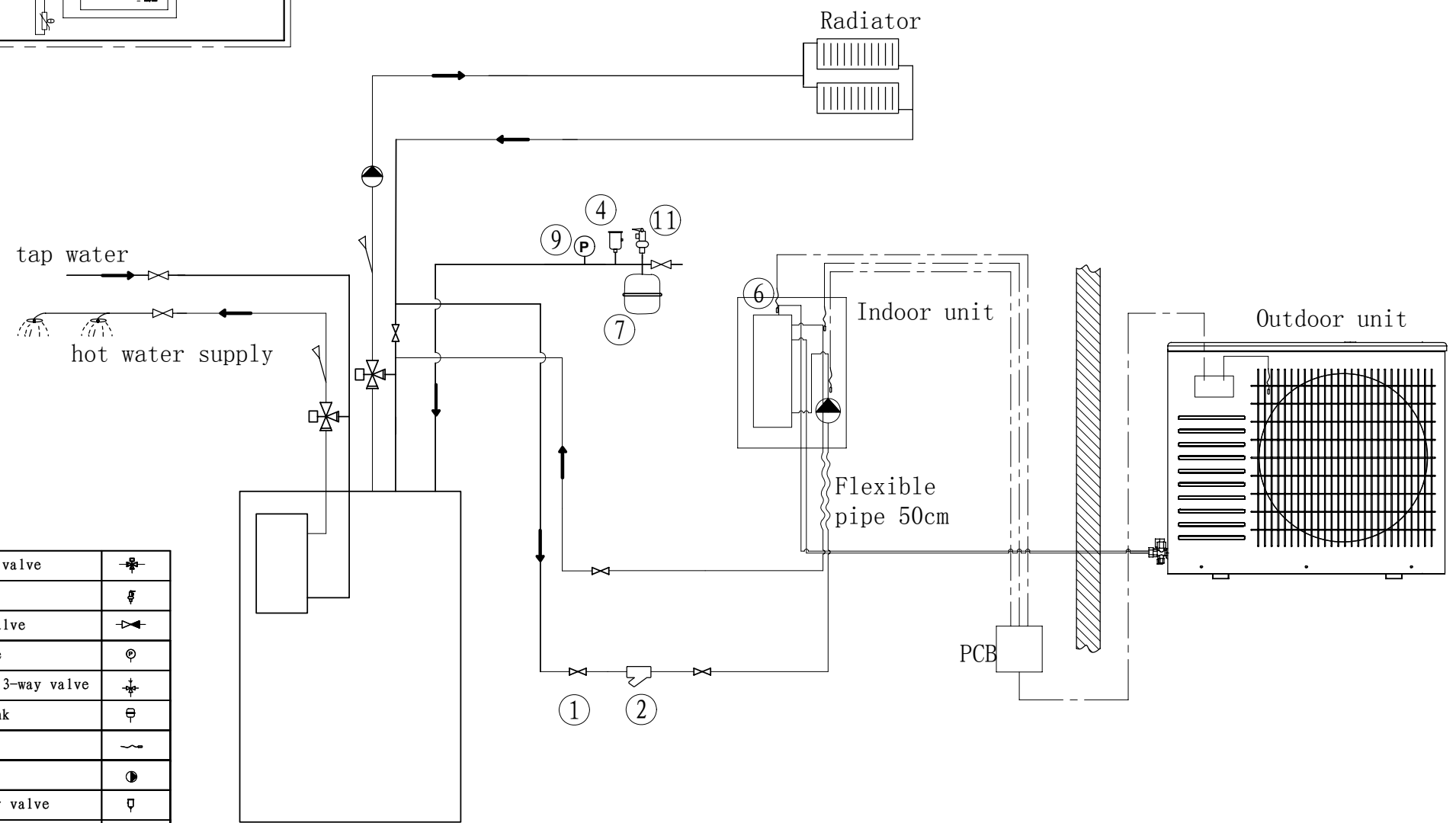

12	water mixing valve	
11	safety valve	
10	non-return valve	
9	pressure gage	
8	electric the 3-way valve	
7	expansion tank	
6	sensor	
5	water pump	
4	automatic air valve	
3	shunt valve	
2	filter ball	
1	shutoff valve	
No	Name	legend

Oil fired boiler

Radiator

Indoor unit

Outdoor unit

Flexible pipe 50cm

PCB

**WIRING DIAGRAM**

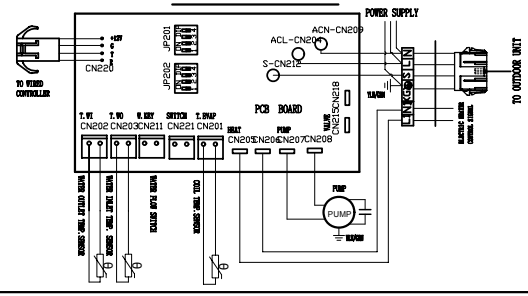

4、AIR WATER + BOILER + SMALL WATER HEATER IN SERIES WITH THE OIL FIRED BOILER.

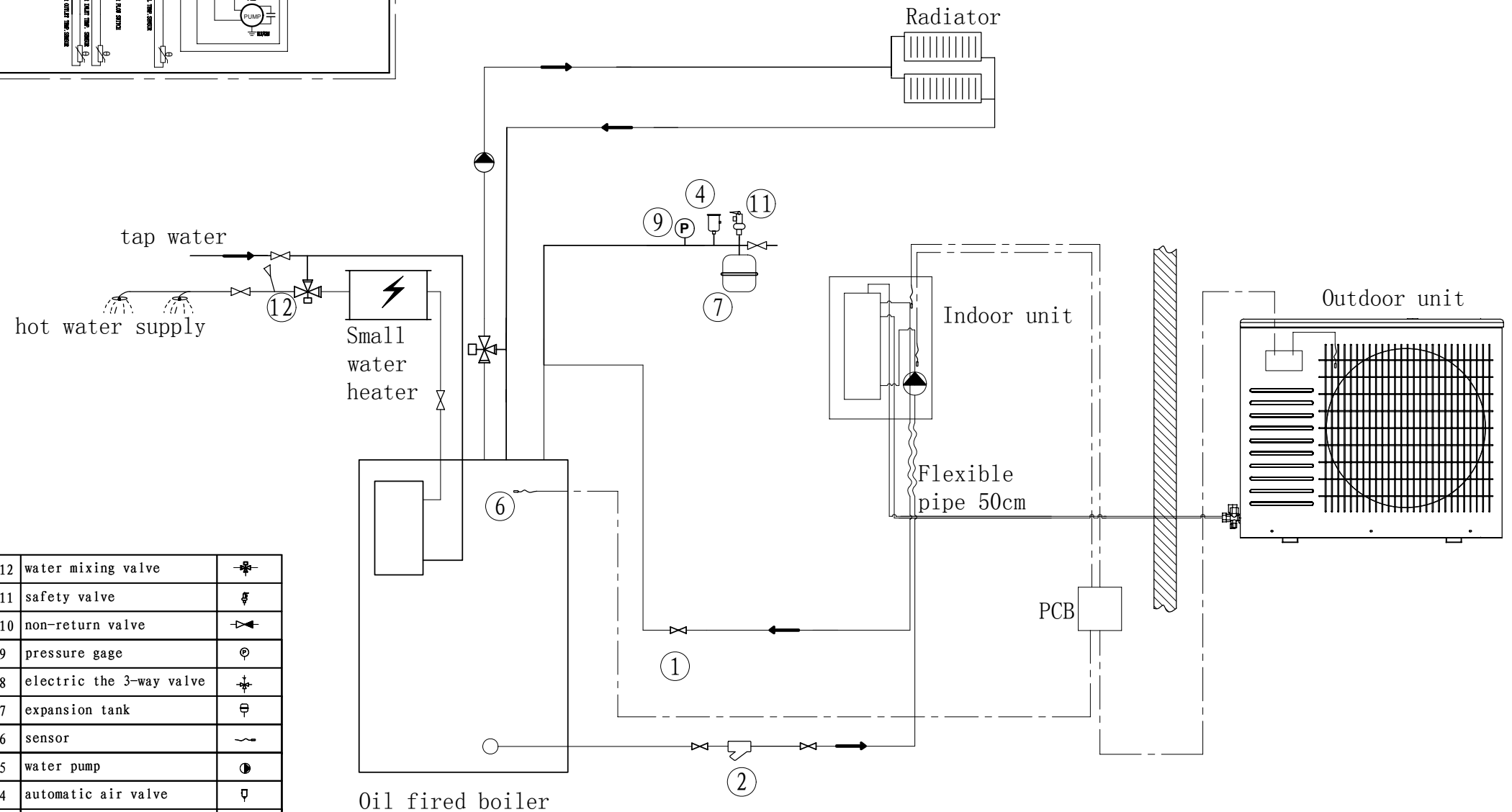

12	water mixing valve	
11	safety valve	
10	non-return valve	
9	pressure gage	
8	electric the 3-way valve	
7	expansion tank	
6	sensor	
5	water pump	
4	automatic air valve	
3	shunt valve	
2	filter ball	
1	shutoff valve	
No	Name	legend

**WIRING DIAGRAM**

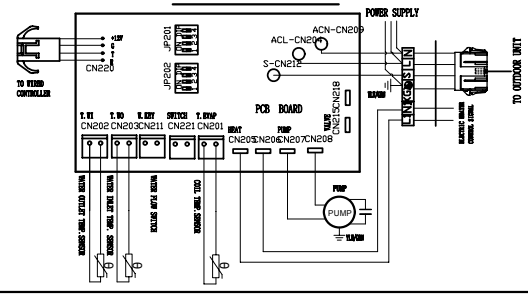

**5、AIR WATER + ELECTRIC BOILER ( HEATING ONLY ) - FLOATING CONDENSATING.**

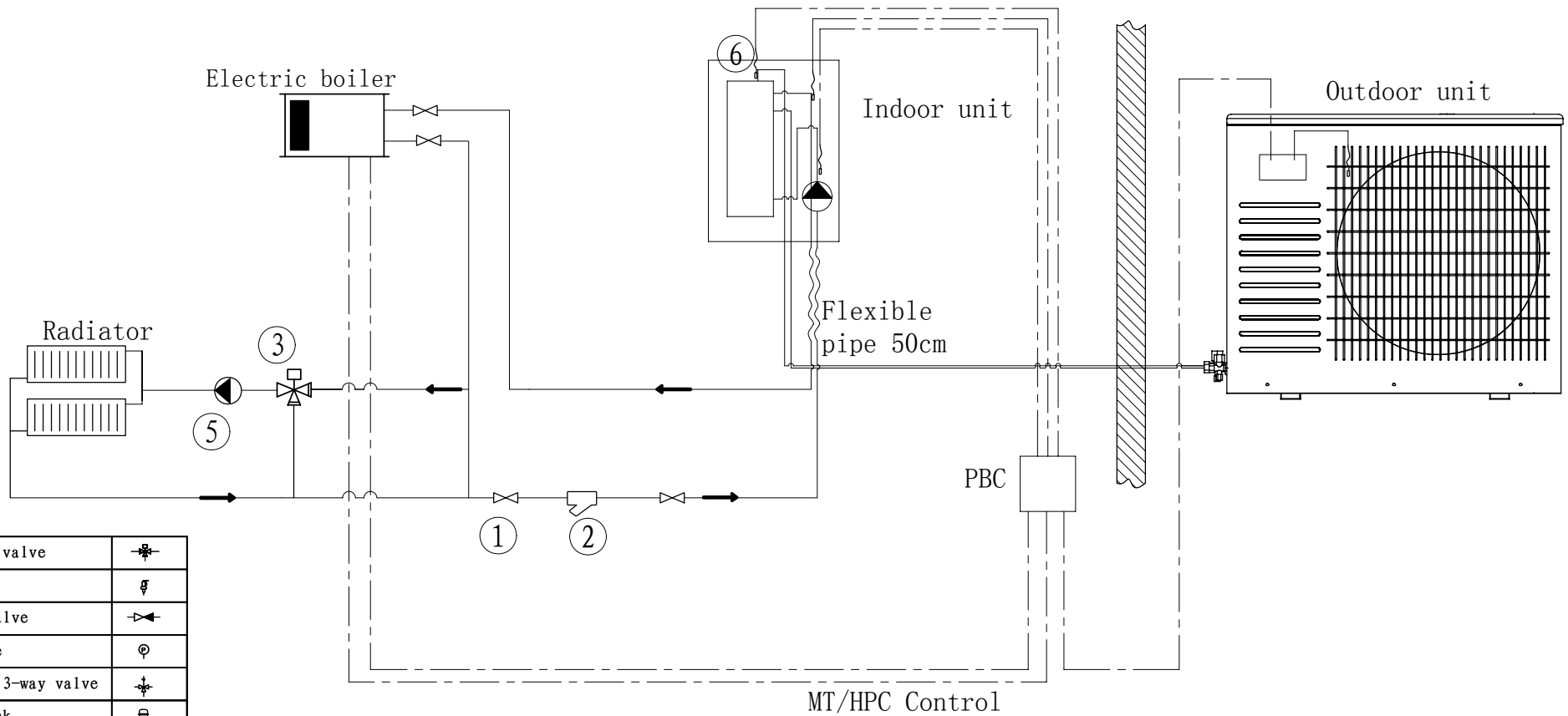

12	water mixing valve	
11	safety valve	
10	non-return valve	
9	pressure gage	
8	electric the 3-way valve	
7	expansion tank	
6	sensor	
5	water pump	
4	automatic air valve	
3	shunt valve	
2	filter ball	
1	shutoff valve	
No	Name	legend

**WIRING DIAGRAM**

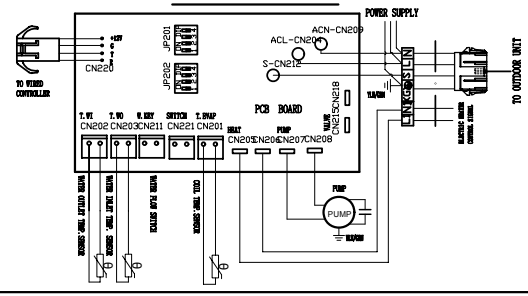

6、AW 24.4 to tank in combine with "pellets/wood/oil burner".

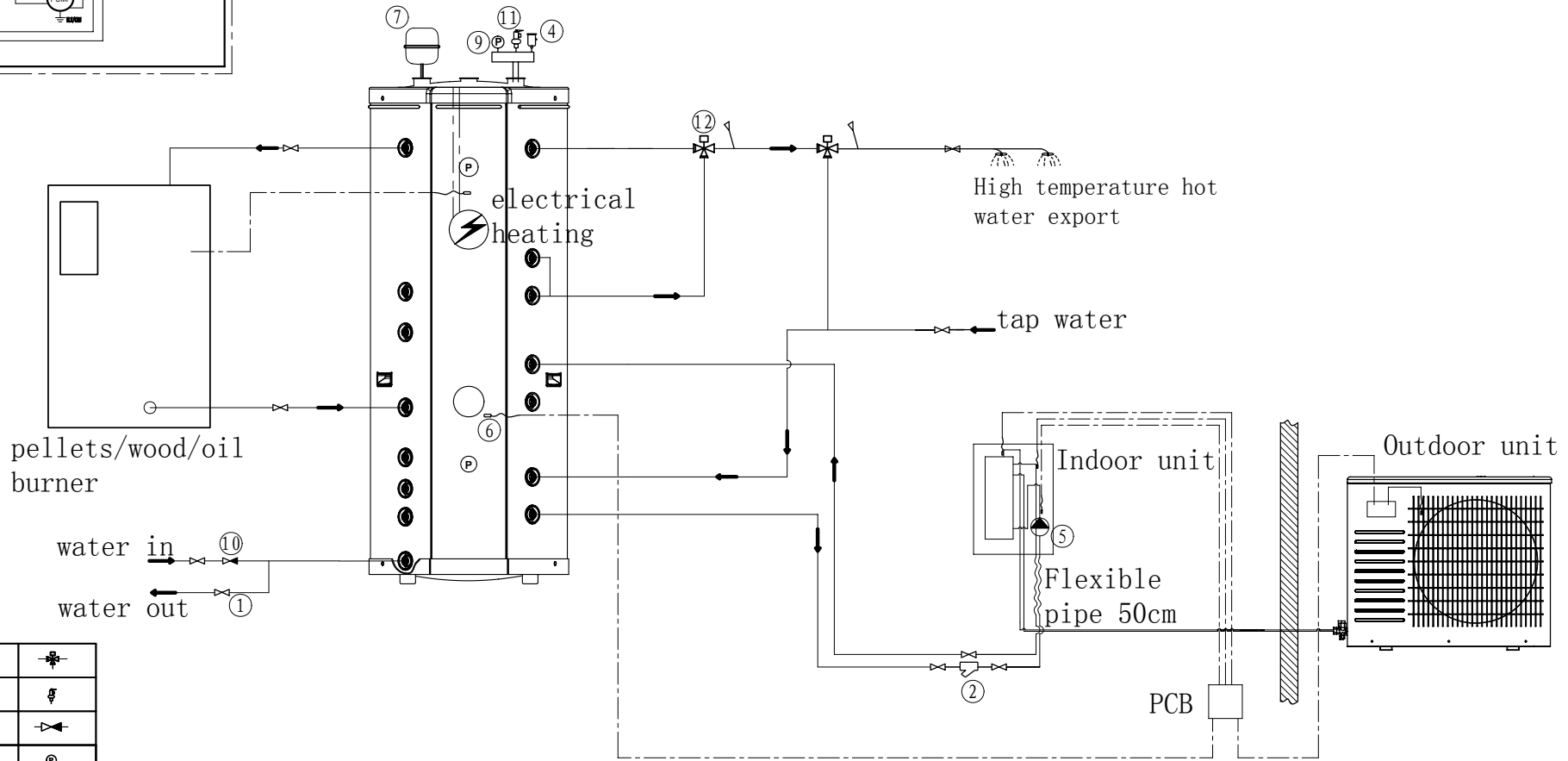

12	water mixing valve	
11	safety valve	
10	non-return valve	
9	pressure gage	
8	electric the 3-way valve	
7	expansion tank	
6	sensor	
5	water pump	
4	automatic air valve	
3	shunt valve	
2	filter ball	
1	shutoff valve	
No	Name	legend

WIRING DIAGRAM

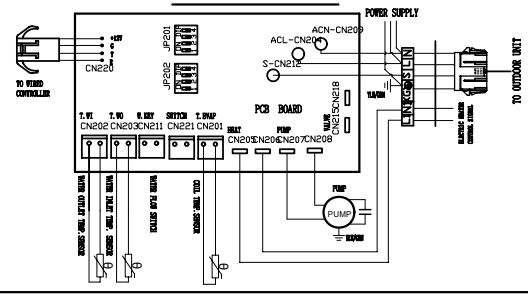

7、AIR WATER + BUFFER TANK.

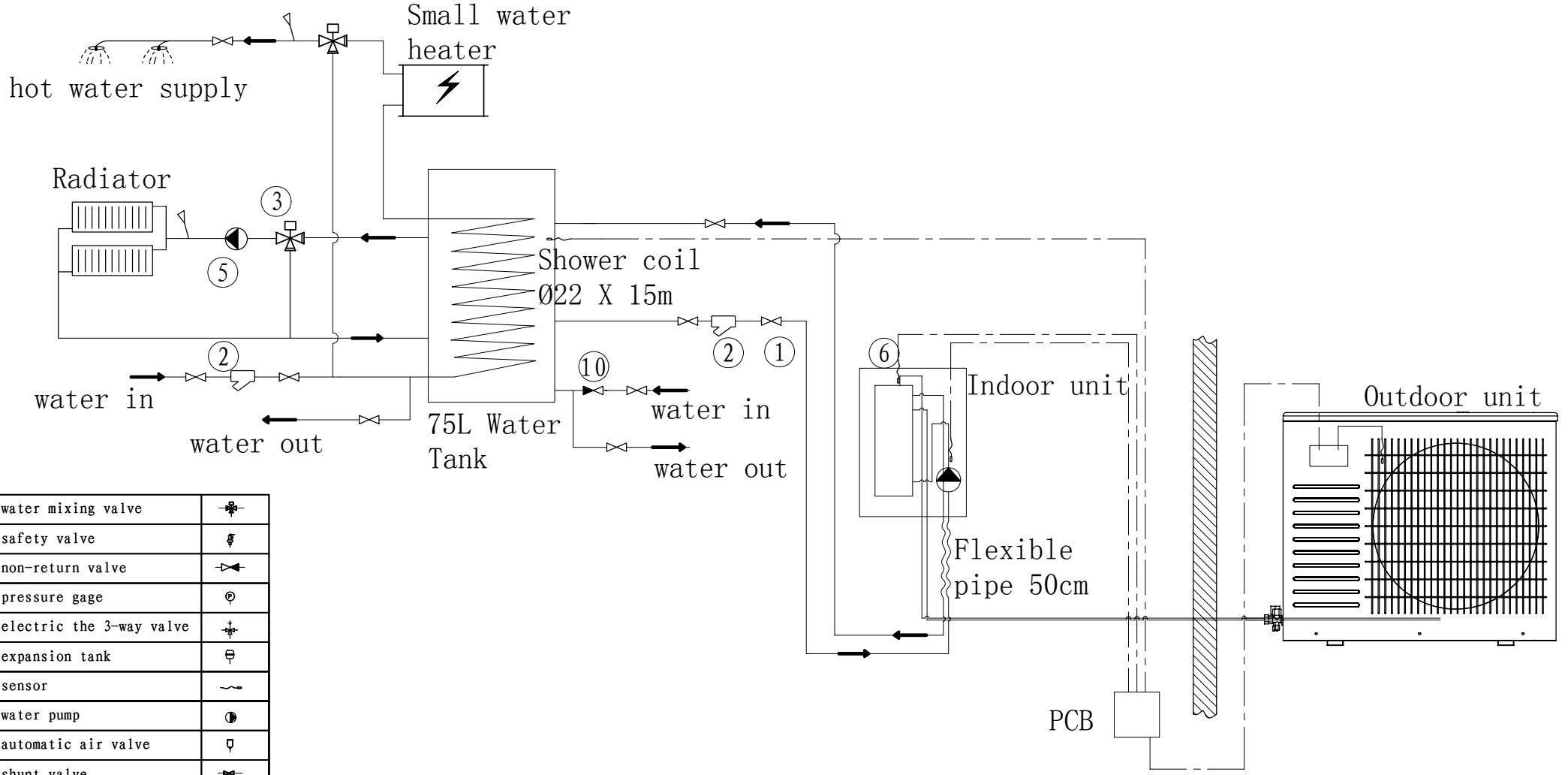

12	water mixing valve	
11	safety valve	
10	non-return valve	
9	pressure gage	
8	electric the 3-way valve	
7	expansion tank	
6	sensor	
5	water pump	
4	automatic air valve	
3	shunt valve	
2	filter ball	
1	shutoff valve	
No	Name	legend